

# Perma<sup>TM</sup> USER MANUAL

Laboratory Device for Testing the  
Rapid Chloride Permeability Test

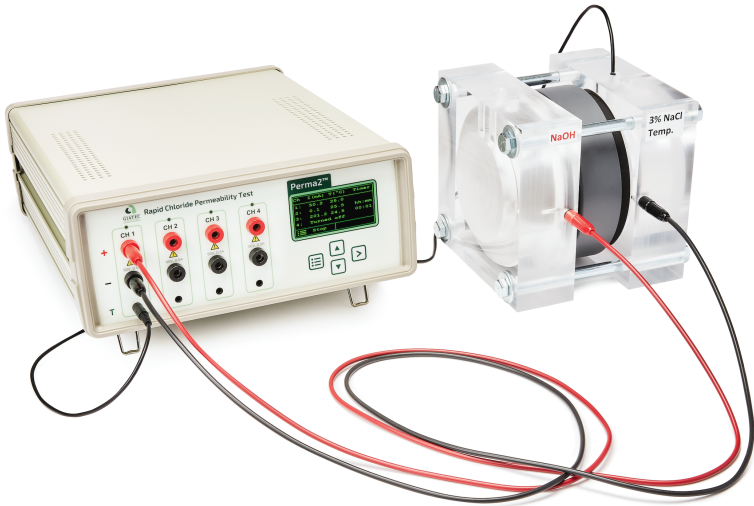

Copyright © 2023 Giatec Scientific Inc. All rights reserved.

**Giatec Scientific Inc.**

245 Menten Pl #300,  
Nepean, ON K2H 9E8

**Support@giatec.ca**

+1 877-497-6278  
www.giatec.ca



---

**TABLE OF CONTENTS**

---

**PACKAGE CONTENTS** ..... III

**WARRANTY** ..... VI

**SAFETY INSTRUCTIONS** ..... 1

    SAFETY SYMBOLS ..... 1

    GENERAL GUIDELINES ..... 1

    DEVICE HANDLING ..... 1

**INTRODUCTION TO Giatec Perma2™** ..... 4

    APPLICATION ..... 5

    MEASUREMENT CONCEPT ..... 5

    DEVICE OVERVIEW ..... 6

**DEVICE OPERATION** ..... 9

    TURN ON Perma2™ ..... 13

    DEVICE SETUP ..... 14

    TESTING STANDARD ..... 14

    DEVICE VERIFICATION ..... 15

    SCREEN CONTRAST ..... 15

    PERFORM THE TEST ..... 16

**MESSAGES** ..... 19

**DATA MONITOR SOFTWARE** ..... 22

    DEVICE DRIVER ..... 22

    INSTALLING DATA MONITOR SOFTWARE ..... 25

    USING DATA MONITOR SOFTWARE ..... 26

    FIRMWARE UPGRADE ..... 34

    DEVICE VERIFICATION ..... 36

*Using the Front Panel* ..... 36

*Using Data Monitor Software*..... 37

**MAINTENANCE** ..... 39

SERVICE ..... 39

REPLACEMENTS..... 39

**Perma2™ TECHNICAL SPECIFICATIONS**..... 40

GENERAL..... 40

OPERATING CONDITIONS..... 40

**TERMS AND CONDITIONS OF SALE**..... 41

**("SALE AGREEMENT")**

EXHIBIT A: END USER SOFTWARE LICENSE ..... 47

---

**PACKAGE CONTENTS**

---

Part	Qty	Picture
Perma2™ Measurement Device	1X	
Test Cable Pair (Black & Red)	4X	
Temperature Sensor	4X	
Cell Block End	8X	
Verification kit	1X	
Spacer Ring	4X	

USB Cable

1X



Steel Bolt

16X



Steel Nut

16X



Steel Washer

16X



Stainless Steel Wire Mesh

8X



Rubber Gasket

8X



Perma2™ Data Monitor Software

1X

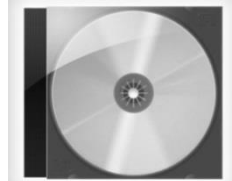

Power Cord

1X



---

\* Please note that the images above are for illustration purpose only and might not be in scale.

## WARRANTY

---

### Limited Warranties

Giatic warrants the Product against defects in materials and workmanship under normal use (the “Warranty”) for a period of 12 months from the Delivery Date (the “Warranty Period”), on the condition that the Product has been completely paid for. Unless as otherwise mandated by local law, the Warranty Period does not restart if Customer receives a replacement appliance and/or replacement Software. This Warranty does not apply: (a) to consumable parts, such as batteries, Plexiglas cell units and cables unless damage has occurred due to a defect in materials or workmanship; (b) to cosmetic damage, including but not limited to scratches, dents and broken plastic on ports; (c) to damage caused by accident, abuse, misuse, neglect or failure to properly maintain (to include but not limited to water damage and/or condensation or improper temperatures during storage), or improper installation; (d) to damage caused by electrical disturbances or acts of God, to include but not limited to civil disturbance, war, flood, fire, rodents or insects; (e) where manufacturer’s serial numbers and security labels have been removed from the Product; and (f) to damage caused during shipment (due to Customer’s improper packaging) from Customer to Giatic in the case of Product returns for repair.

Giatic disclaims all other warranties, express or implied, including without limitation implied warranties of merchantability, fitness for a particular purpose, or against hidden or latent defects. Giatic’s responsibility for warranty claims is limited to repair or replacement. Giatic reserves the right to modify this Warranty at any time, at its sole discretion, and with notice to Customer.

Giatic does not warrant that the operation of the Product will be uninterrupted or error-free. Giatic is not responsible for damage arising from failure to follow instructions relating to the Product’s use. This Warranty is voided immediately if repair, modification (to include upgrades, expansions or usage or addition of non-manufacturer parts or accessories), alteration or other service is attempted other than by Giatic. In this regard, the integrity of the appliance casing (aka the box) should not be violated for any reason, unless expressly authorized by Giatic in writing.



THE WARRANTY SET FORTH IS EXCLUSIVE AND NO OTHER WARRANTY, WHETHER WRITTEN OR ORAL, IS EXPRESSED OR IMPLIED. GIATEC SCIENTIFIC INC. SPECIFICALLY DISCLAIMS THE IMPLIED WARRANTIES OF MERCHANTABILITY AND FITNESS FOR A PARTICULAR PURPOSE.

*\* Please refer to the complete Terms and Conditions of Giatec's products for more details.*

*\* The information contained in this document is subject to change without notice.*

## SAFETY INSTRUCTIONS

---

This chapter contains important safety instructions that the user must follow for operation and storage of Giatec Perma2™. Read the following safety information before any operation to ensure your safety and to keep the instrument in good condition. Keep the manual in a safe place for future reference.

### SAFETY SYMBOLS

In order to ensure the safety of the operator, and increasing the service life of the instruments, pay attention to safety precautions described in this manual. These messages are indicated by a  symbol throughout this user manual.

- |            |  |
|------------|--|
| WARNING:   | Identifies conditions or practices that could result in injury or loss of life.                          |
| CAUTION:   | Identifies conditions or practices that could result in damage to Giatec Perma2™ or to other properties. |
| ATTENTION: | Refer to the User Manual   |

### GENERAL GUIDELINES

1. Always follow basic safety precautions when using this product to reduce risk of injury from fire or electric shock.
2. Read and understand all instructions in the documentation that comes with Giatec Perma2™.
3. Observe all warnings and instructions marked on the product.

### DEVICE HANDLING



#### CAUTION

---

Giatec Perma2™ device is a delicate testing instrument. The electronic parts and test cells are sensitive components. Please handle them with care.

- Do not place any heavy objects on Perma2™ Measurement device
- Avoid severe impact or rough handling that might damage the device or the cells.
- Do not disassemble Perma2™.

- Install the product in a protected location where no one can step on or trip over the power cord and in a location where the power cord cannot be damaged.

## OPERATION



### WARNING

---

- AC Input voltage: 100 ~ 240 V, 50/60Hz.
- Leave at least 100mm (4") room behind Perma2™ to allow for ventilation.
- Do not perform measurement on or connect the test leads to circuits directly connected to Mains (Live circuit).
- Keep the instrument in a place where the chance of spilling liquids on the device is negligible.
- Only replace the fuse with the exact one mentioned on the marking at the back of the unit.
- Avoid touching the output terminals or end metal parts of the test cables when the device is ON.

## CLEANING THE INSTRUMENT



### ATTENTION

---

- Unplug this product from wall outlets before cleaning.
- Use a soft cloth dampened in isopropanol alcohol or water.
- Do not use chemicals or cleaners containing harsh products such as benzene, toluene, xylene, and acetone.

## OPERATION ENVIRONMENT



### ATTENTION

---

- Do not block ventilation holes on the top of the device.
- Place the instrument in a well-ventilated area.
- Avoid blocking the fan output at the rear of the instrument.

## STORAGE ENVIRONMENT



### ATTENTION

---

- Location: Indoor
- Relative Humidity: 5% to 90%
- Temperature: 0°C to 70°C

---

## INTRODUCTION TO GIATEC Perma2™

---

Giatic Perma2™ is a re-engineered laboratory test device for measuring the resistance of concrete to the penetration of chloride ion. The test procedure is consistent with different standards, including:

- ASTM C1202 / AASHTO T277
- ASTM C1760

The device is capable of measuring the electrical charge passing through a standard concrete sample. The Perma2™ device can be operated as a stand-alone unit or controlled using the Data Monitor PC software. The measurements can be used in the performance-based quality control of concrete materials. Measurements can also be used to estimate the chloride diffusion coefficient of concrete for the purpose of service life prediction.

The ASTM C1202 test provides an indication of concrete resistance to the penetration of chloride. A widely accepted qualitative relationship (see Table 1) between the electrical charge (measured according to ASTM C1202) and the long-term chloride penetrability of concrete was originally proposed by Whiting et al. (1981).

**Table 1:** Chloride ion penetrability based on charge passed (ASTM C1202)

Chloride Penetration	56-Day Rapid Chloride Permeability Charge Passed (Coulombs)
High	>4,000
Moderate	2,000 to 4,000
Low	1,000 to 2,000
Very Low	100 to 1,000
Negligible	<100

An alternative procedure to the test was proposed and standardized (ASTM C1760) to predict the bulk electrical conductivity of saturated specimens of hardened concrete. The results reveal a rapid indication (i.e. in one minute) of the concrete's resistance to the penetration of chloride by diffusion. The results of this test method can be also related to the

apparent chloride diffusion coefficient that is determined using ASTM C1556 test method.

### APPLICATION

Perma2™ is a laboratory device for testing the durability of concrete that is or has been exposed to chloride-contaminated environment including:

- Concrete's ability to resist chloride ion penetration (ASTM C1202, AASHTO T277)
- Bulk electrical conductivity of concrete (ASTM C1760)
- Performance-based quality control of concrete
- Estimation of the chloride diffusion coefficient of concrete
- Estimation of the chloride migration coefficient of concrete
- Service life design of concrete structures
- Estimation of the remaining service life of concrete structures

### MEASUREMENT CONCEPT

Fig. 1 depicts a typical functional diagram for one of the four channels available on the device. In accordance with the testing standards requirements, each channel must be supplied by a controlled precision

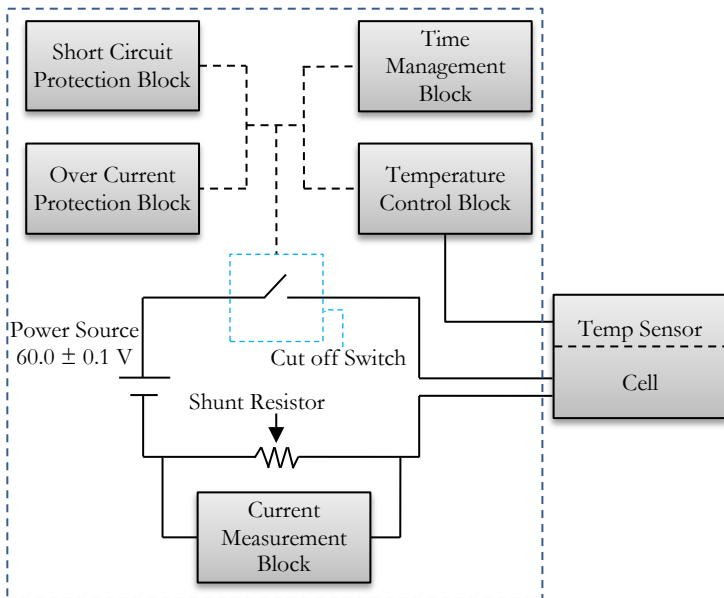

Figure 1: Electrical Block Diagram of Perma2™ device

$60 \pm 0.1$  DC voltage source. The electrical current passing through the cell is measured through an accurate and stable shunt resistor. The electrical potential over this shunt resistor will be used to calculate the current passing through the cell.

Each channel is protected against short circuit to prevent damage to the device and the test cells in case of faulty connection in the output circuitry. The short circuit protection system is also designed to reduce the fire hazard from excessive temperature rise in wires during a prolonged short circuit period. In addition, each output port is monitored continuously for its current consumption to limit the maximum allowable current to  $504 \pm 5$  mA. A current consumption in excess of this limit would automatically turn off the overloaded channel.

The temperature of each test cell is continuously monitored with the accuracy of  $\pm 1^\circ\text{C}$  using the temperature sensors to prevent overheating that might damage the test apparatus. When the temperature inside a cell reaches  $90.5 \pm 1^\circ\text{C}$ , the corresponding channel will be turned off automatically.

The duration of the test is also controlled by an internal clock system which will disconnect the power from the channels once the test is completed.

## DEVICE OVERVIEW

Giatic Perma2™ has two main components: A measuring device (Fig. 2, and 3), and four concrete sample cells (Fig. 4). The measuring device can be used as a stand-alone equipment to perform the tests. It can also be connected to a personal computer (PC) using the USB connection port. The Data Monitor software provided in the package controls the device and also records the measurement data. In this section, the key functions of these components are described.

### Measuring Device

The front panel of the measuring device includes channel ports (see Fig. 2 Items 1, 2 and 3), Display, and the control keypad. The test cells are connected to the measuring device using the cables included in the package.

### Front Panel

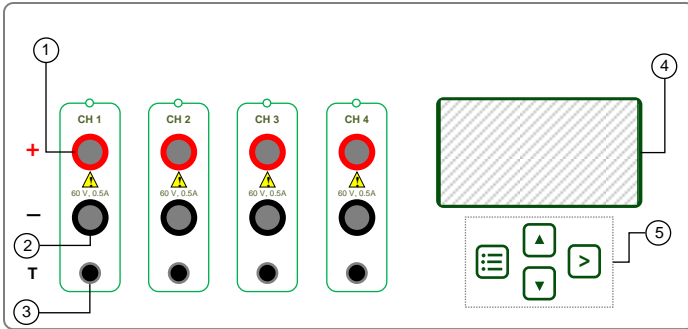

Figure 2: Front Panel View

1. Positive Connection Port
2. Negative Connection Port
3. Temperature Sensor Connection
4. LCD Screen
5. Control Keypad

### Back Panel

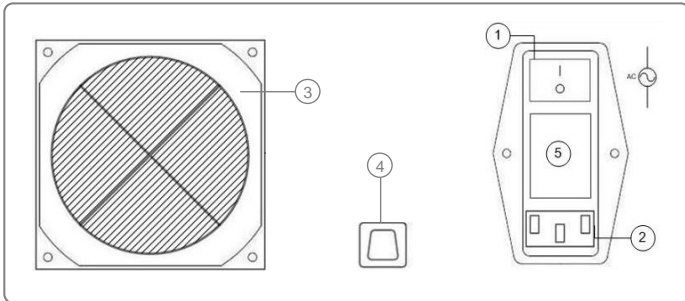

Figure 3: Back Panel View

1. Power Switch
2. Power Inlet
3. Cooling Fan
4. USB Communication Cable Port
5. Fuse Box



## Test Cell

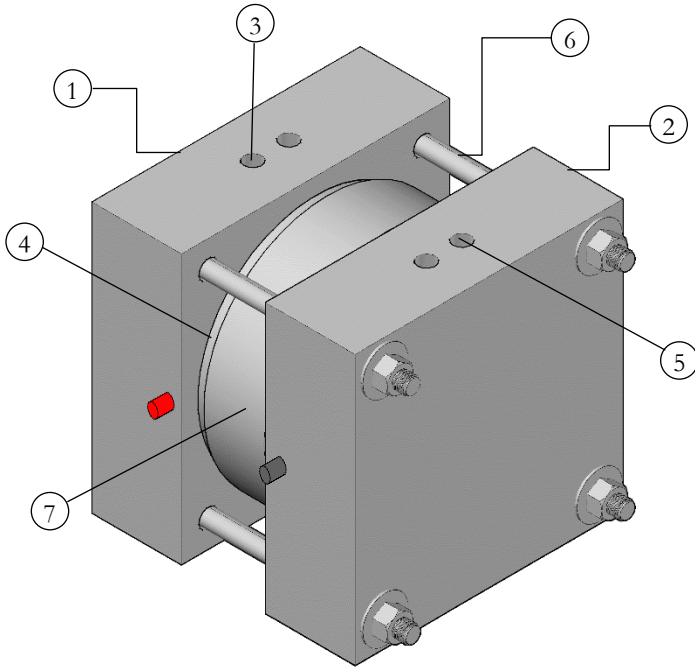

Figure 4: Assembled Test Cell

The assembled Perma2™ test cell

1. Left Cell Block End
2. Right Cell Block End
3. Liquid Solution Filling Inlet
4. Rubber Gasket
5. Temperature Sensor Inlet
6. Steel Bolt
7. Spacer Ring

---

## DEVICE OPERATION

---

Before starting the test, make sure that the concrete specimens meet the requirements of the standards. Then, the concrete specimen should be installed in the test cell properly. In order to run a test, follow the step-by-step instructions below:

### Preparing the Test Cells

**Step 1:** The stainless steel wire mesh must be placed inside each test cell's cup and the corresponding connector must be tightened to provide a firm electrical connection between the mesh and the connector.

The bolts with provided washers should be inserted into the holes located at the four corners of the cell.

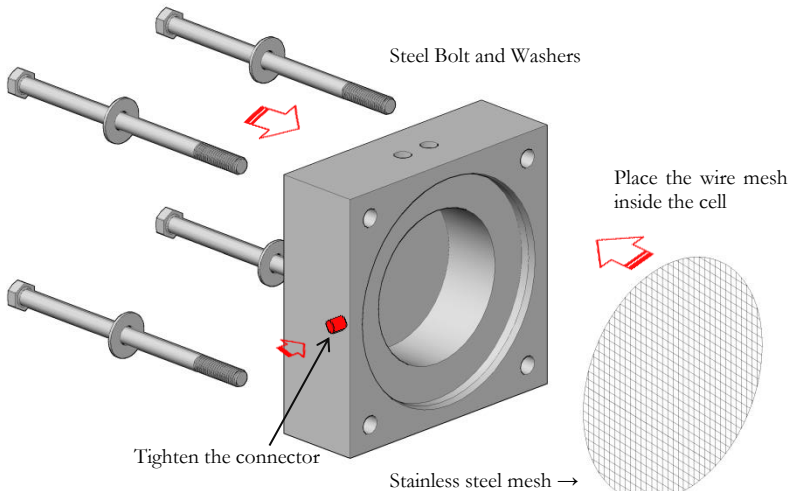

Place the steel wire mesh inside each Test Cell container

**Step 2:** Place one rubber gasket at one end of the specimen. Then place the spacer ring around the specimen. Push the second rubber gasket to the other end of the specimen. Make sure that the spacer ring is located right at the middle of the concrete sample by adjusting the location of the rubber gaskets.

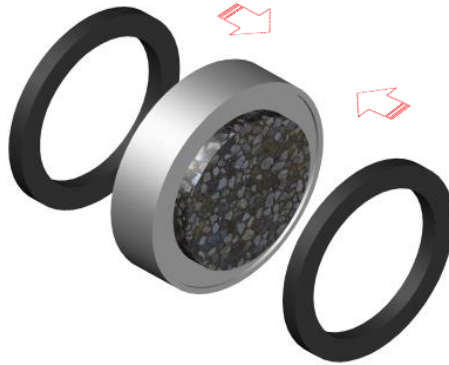

Place the gasket and the spacer

**Step 3:** Place the assembled unit into the test cell.

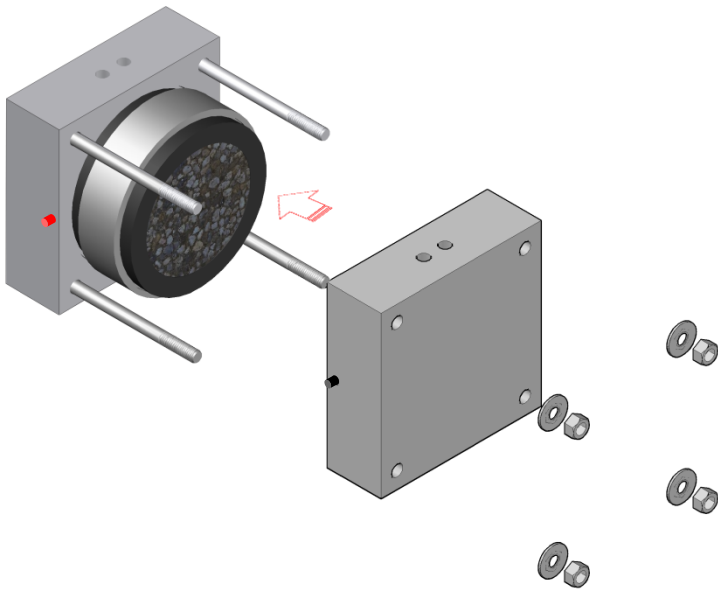

Insert the prepared sample assembly into the cell, and fasten the nuts

**Step 4:** Place the second piece of the cell as described in the figure above. Carefully pass the bolts through the holes on the corners, and place the washers and nuts. Using an appropriate wrench, tighten the bolt-nut combination.

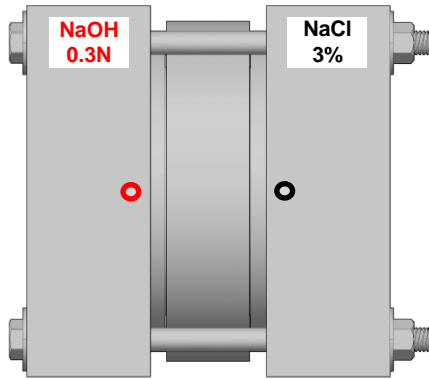

Ready to test Cell- front view

### Filling the Test Cell

In order to fill the cell containers, place the cell such that the filling inlets are facing upward. Fill the right container (with black color jack) with 3.0% NaCl and the left container (with red color jack) with 0.3 Normal NaOH solution.

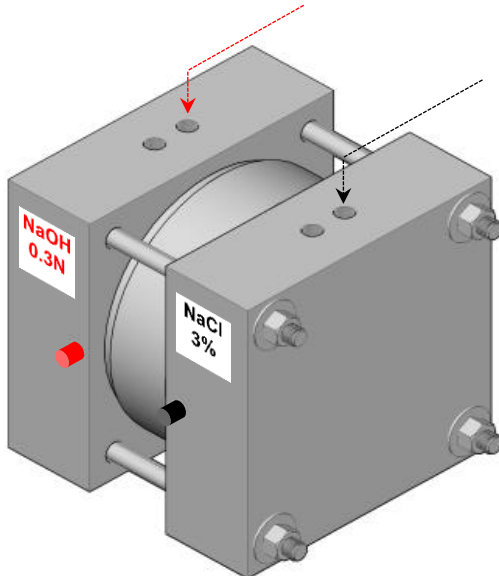

Fill the test cell containers with NaOH and NaCl solutions



DO NOT close the filling inlets during the test.

DO NOT fill the test cells with the liquids when the test is running.

## Leakage Test

Once the test cells are filled up with the solutions, the leakage test must be conducted as follows:

Control the level of liquids inside each container. If the level of the liquids is not constant within ten minutes, or if any dripping is observed below the cell, there may be a leak between the gasket and the specimen surface or between the test cell and connectors. Any leakage problem should be fixed before starting the test.

If the leakage is between the gasket and the specimen surface, try tightening the bolts and refilling the cell containers. If the source of leakage is between the cell and connectors, try tightening the connector, if it is possible. Otherwise, use silicon glue to seal the space between the connector and the cell. You may also need to adjust the position of the rubber gaskets and ensure they are properly located within the Plexiglas cell part to fix the leakage problem.



To avoid electric shock, all the cells must be leak free before running the test.

Disconnect the test cells from the measuring device before checking or fixing the leakage.

## Connect the Test Cells to the Measuring Device



To avoid electric shock, the device must be turned off before connecting any cables and cells.

Each cell should be connected to the corresponding channels on the front panel. The red connector of the cell (+) should be connected to the red terminal of the channel using the red cable. In a similar way, connect the black terminal to the black connector on the other half of the cell (-). The temperature sensor should also be placed inside the NaCl container. The other end of the temperature sensor cable should be connected to the designated terminal on the front panel.

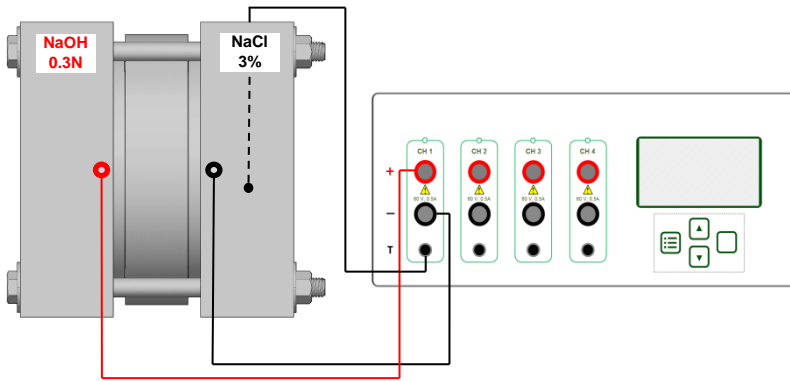

Connection diagram shows the details of the cable connections

## TURN ON Perma2™



Before turning on the device, make sure that the cable, sensors, and test cells are connected to the appropriate connection terminals. Also make sure that there is no short circuit.

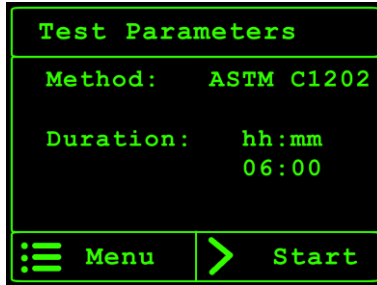

The main power switch of Perma2™ is located on the back panel of the device. Turn the switch from **O**-off to **I**-on. The LCD screen on the front panel will turn on; after a few seconds, the **Test Parameters** menu will appear on the LCD screen.

The default test method is set to ASTM C1202. If you want to perform the test according to ASTM C1760, you should change the test method using the options available in the Menu.



Test Parameters on the LCD display

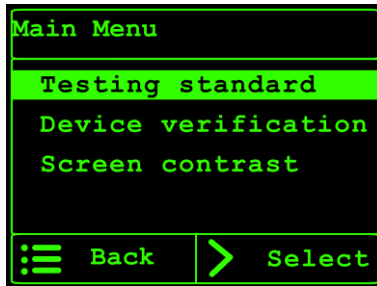

## DEVICE SETUP

The system setup can be changed by pressing the **Menu**  key on the front panel. The menu options will then appear on the LCD display. Using the **Up**  and **Down**  keys on the front panel, the user can access these options.



Main Menu on the LCD display

## TESTING STANDARD

The user can change the test method by selecting either of the two available standard test procedures: ASTM C1202, or ASTM C1760. You can select the test method by using the **Up**  and **Down**  keys on the front panel. Press **Select**  to choose your test method.



Testing standard on the LCD display

## DEVICE VERIFICATION

The verification kit is a useful accessory kit that can be used to ensure the appropriate functionality of the Perma2™ system. In order to verify the device, select the verification option in the Main Menu and follow the instructions.

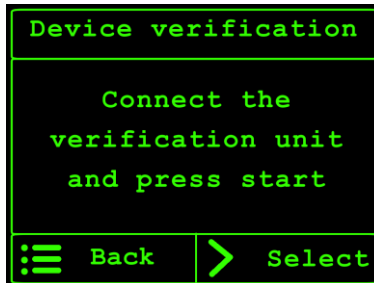

Device verification on the LCD display

## SCREEN CONTRAST

In order to adjust the contrast of the device display, use the Up  key to increase the contrast or the Down  key to reduce the contrast.



Screen contrast on the LCD display



## PERFORM THE TEST

In the main menu, select the test method you want to use: **ASTM C1202**, or **ASTM C1760**.

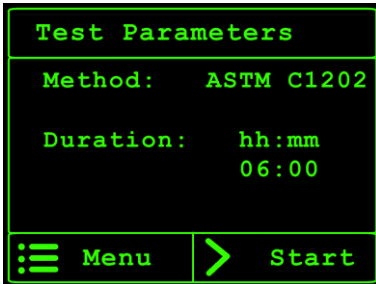

ASTM C1202

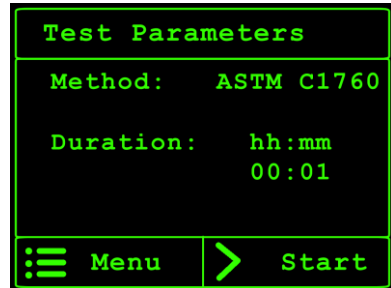

ASTM C1760

Press the **Start**  key on the front panel to start the test; all four channels will be checked by the system to ensure their appropriate functionality before starting the test.

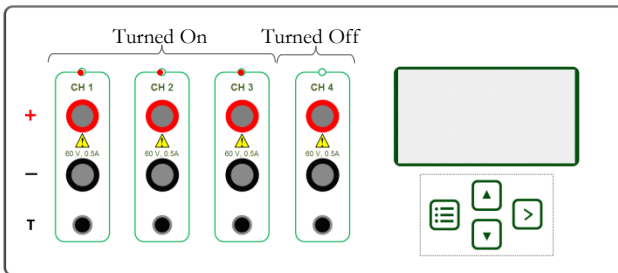

If the channel is working properly, the values of the current and temperature will appear in front of the channel number on the display and the red LED lights on the front panel will turn on.



Ch	I (mA)	T (°C)	Timer
1:	50.2	25.0	
2:	0.1	25.5	hh:mm
3:	201.2	24.5	04:25
4:	350.3	25.1	

Ch	I (mA)	T (°C)	Timer
1:	50.2	25.0	
2:	0.1	25.5	hh:mm
3:	201.2	24.5	00:01
4:	Turned off		

Measured current and temperature during the test

For those channels that are not connected to the measuring device, the corresponding LED light will remain off during the test. No data will be recorded for these channels. A turned off message will appear in front of the channel number.

If there is any error, a specific error message will appear. Refer to the ERROR section of this user manual for information regarding the troubleshooting of the malfunctioning channels.

At any time during the test, the user can terminate the test by pressing the **STOP**  key. A message will appear on the screen to verify the termination of the test. By pressing the **YES**  key, the test will be terminated. For an incomplete test, using the recorded data the total electrical charge until the termination time will be calculated and displayed on the screen. The user can choose to continue the test by pressing the **NO**  key.

Ch	Charge (C)
1:	1085
2:	3010
3:	4200
4:	Turned off
Turn off the device	

Ch	I (mA)
1:	50.2
2:	.1
3:	201.2
4:	Turned off
Turn off the device	

The end of the test

When the test is completed, the channel(s) will be turned off; for ASTM C 1202, the total electrical charge will be calculated and displayed in front of the channel number; for ASTM C1760, the current value after 1 minute will be displayed in front of the channel number.

**a) ASTM C1202:** in this test, the total electrical charge (Coulomb) for each specimen is calculated by integrating the area under the current curve. This area can be calculated using the trapezoidal rule.

$$Q = \frac{I}{2} \Delta t \{ I_0 + 2I_{\Delta t} + \dots + 2I_{t-\Delta t} + I_t \}$$

Where  $Q$ , is the total electrical charge (Coulombs),  $t$  and  $\Delta t$  (seconds), are the total duration of the test, and sampling intervals, respectively, and  $I$  is the electric current (Amperes).

## Sample Calculations

If the current is recorded at 30 min intervals, the total electric charge can be calculated as:

$$Q = \frac{1}{2} 1800 (I_0 + 2I_{30} + 2I_{60} + \dots + 2I_{330} + I_{360})$$

**b) ASTM C1760:** in this test, the value of electric current will be displayed at the end of the 60 second test period.

The user needs to record the results (as there is no onboard memory) and turn off the device in order to set up the next series of test samples.



During the sample replacement, the device must be kept off to avoid electrical shock hazard.

To avoid electric shock, the device must be turned off before connecting any cables and cells. Placing the temperature sensor in the positive cell might cause a serious damage to the device if the epoxy on the tip of the sensor is damaged. Therefore, it is highly recommended to place the supplied temperature sensor in the cell with black jack containing sodium chloride solution that is connected to the negative terminal.

---

## MESSAGES

---

Perma2™ has been designed and tested to the highest standards to ensure the safety of the user and the instrument. Several safety measures have been implemented in the device. Depending on the situation, one or more of these features might prevent the unit from continuing its normal functions. The channels are designed to work individually, therefore, these safety features will only apply to the channel experiencing trouble. In this case, a message will appear on the display.

### Turn Off

The channel(s) will automatically be turned off if no electric current is drawn following the start of the test. In this case, a “**Turned off**” message will appear in front of the channel name on the display. This condition could arise in one or more following conditions:

- Test cables are not connected to the cell or the device (or are loose).
- No liquid was poured into test cell.
- The sample were not fully saturated before running the test.

Ch	I (mA)	T (°C)	Timer
1:	50.2	25.0	
2:	.1	25.5	hh:mm
3:	201.2	24.5	04:25
4:	Turned off		
☰ Stop			

Communication error in Channel 4



If all four channels are disconnected, the “turned off” message will appear for all channels. The user has to press the stop key to terminate the test. The user is then asked to turn off the device using the main power key on the back panel and check the test cells and wires.

### ADC Err.

When the current measurement circuit does not function properly, the “**ADC Err.**” message will appear on the display. To resolve the issue, try turning off the device first, and then turn it on after a few seconds. If the issue is not resolved, contact Giatec customer service.

### Short Circuit

If the positive and negative test leads are short circuited to each other by error when connecting them together, the channel with this fault will be turned off and “**short cir.**” Message will be showed on display.



Turn off the device and remove the short circuit before restarting the test.

### Disconnected Sensor

If the temperature sensor is not connected to the test device, or if the temperature sensor is damaged, a “**DC**” message will appear in front of the channel number under the temperature column. As soon as the temperature sensor is appropriately connected to the device, the temperature value will appear on the LCD display.

Ch	I (mA)	T (°C)	Timer
1:	50.2	25.0	
2:	.1	25.5	hh:mm
3:	201.2	24.5	00:01
4:	320.6	DC	
☰ Stop			

Temperature error in Channel 4

## Over Current

The electric current on each channel is continuously monitored so that the maximum allowable current is not exceeded. The current is limited to  $504 \pm 2$  mA; if the current exceeds this value, the channel will be turned off automatically. The “**Over curr.**” message will appear in front of the corresponding channel name on the display and the channel will be turned off. No additional data will be recorded from a turned-off channel.

Ch	I (mA)	T (°C)	Timer
1:	50.2	25.0	
2:	.1	25.5	hh:mm
3:	201.2	24.5	00:01
4:	Over curr.		
☰ Stop			

Over current error in Channel 4

## Over Heat

If the temperature in the test cell exceeds  $90.5 \pm 1$  °C, the channel will be turned off, and the “**Over heat**” message will appear in front of the channel name on the display.

Ch	I (mA)	T (°C)	Timer
1:	50.2	25.0	
2:	.1	25.5	hh:mm
3:	201.2	24.5	00:01
4:	Over heat		
☰ Stop			

Over Heat error in Channel 4



If the temperature sensor is not connected to the device, or if the temperature sensor is not working properly, the overheat check will not work and device will not be able to shut down the channels. There is a chance that the test cell can be seriously damaged if it becomes overheated.

---

## DATA MONITOR SOFTWARE

---

Perma2™ Data Monitor software can be used to control the measuring device, perform the tests, and log the test data on your computer. In order to be able to use the Perma2™ Data Monitor, you have to install the software on your PC. You should also connect the measuring device to the PC using the USB cable provided.

### DEVICE DRIVER

When you connect the Perma2™ measuring device to your computer for the first time, Microsoft Windows will automatically install the required driver if your computer has access to internet. A pop-up message will appear on the lower right corner of the screen (Windows taskbar).

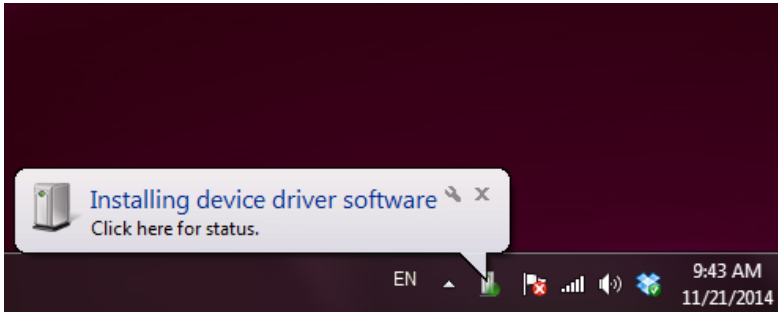

Installing the device driver

When the installation has successfully completed, a message will appear confirming the installation:

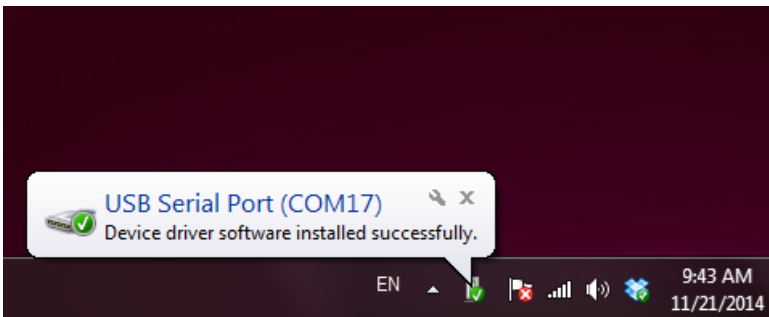

USB Serial Port successfully installed on the computer

If your computer is running an older version of Windows (i.e., XP or 2000), or if your computer does not have internet access, you have to install the driver manually.

The driver file is located on the Perma2 Data Monitor CD. In order to install, or update a previously unsuccessful installation, go to the **Device Manager**. In Windows, you can access **Device Manager** under **System** in the **Control Panel**.

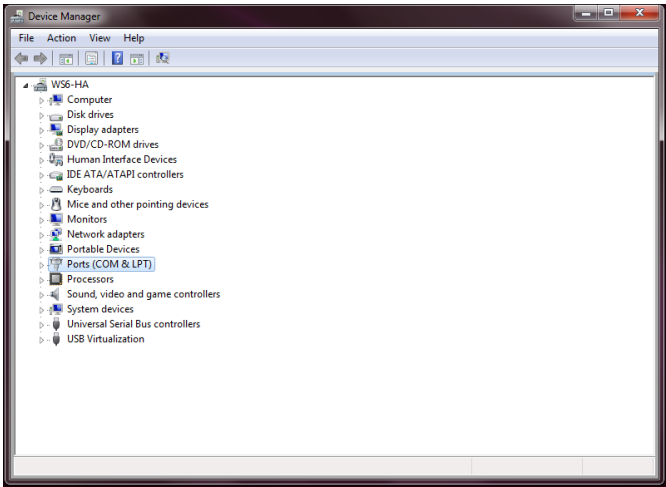

Device Manager window

Right click on the **USB Serial Port**, and select **Update Driver Software**.

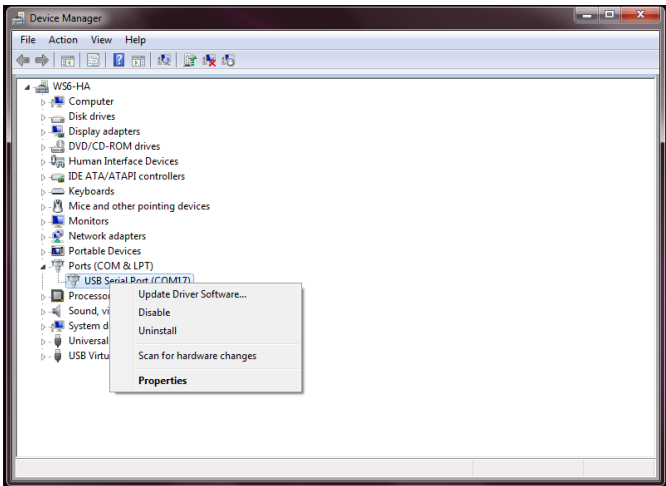

Update Driver Software



Click on “Browse my computer for driver software”

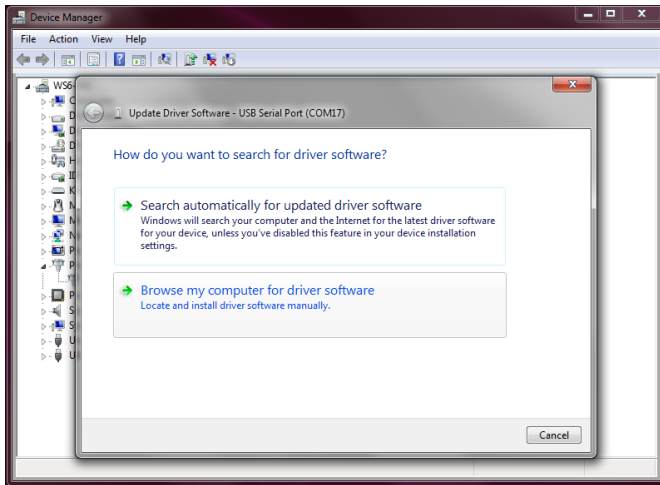

Select Browse my computer

Select the Driver provided on the software CD and click on Next to install the driver.

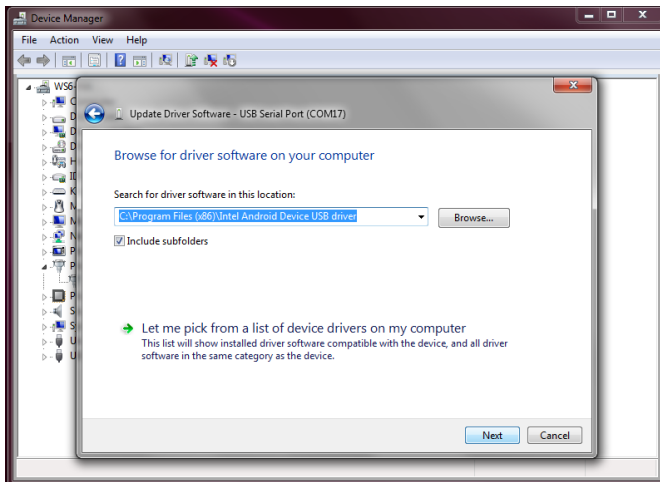

Select the driver file and browse for the file on the CD

## INSTALLING DATA MONITOR SOFTWARE

Insert the Perma2 Data Monitor software CD in your computer's CD-ROM drive. The Setup file is an autorun application. If the autorun did not start automatically, you can start the setup by clicking on the setup icon in the installation CD.

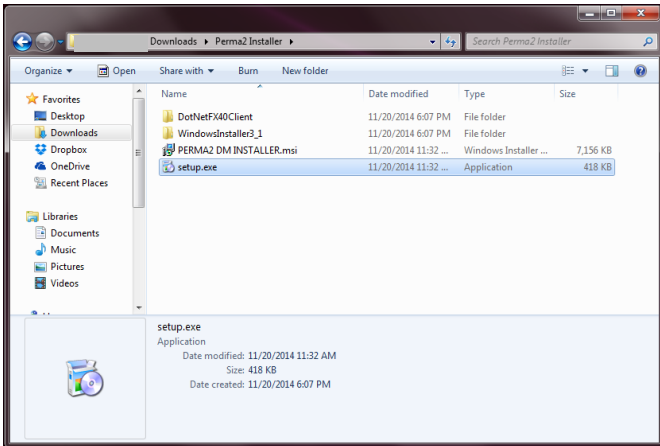

Click on Setup to start installing the Perma2 Data Monitor

The setup wizard will guide you through the rest of the installation. Follow the instructions on your screen to install the software. This process may be different depending on the version of your operating system (Windows XP, 2000, 7 or 8). Following a successful installation, a Perma2™ Data Monitor icon will be created on your desktop. Click on this icon to run the software.

## USING DATA MONITOR SOFTWARE

Click on the Perma2™ Data Monitor icon on the desktop to launch the software. Alternatively, you can open the software from the **Programs** in the windows **Start Menu**.



The device should be connected to the PC with the USB cable, and turned on before launching the Data Monitor software.

The Perma2™ Data Monitor home window will appear on the screen. The menu strip box at the top of this form helps the user to perform different tasks.

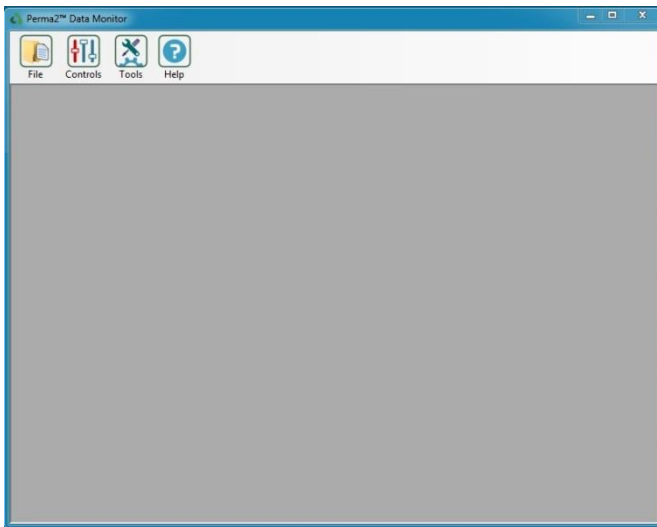

Data Monitor home screen

In this section, the function of these menu items (File, Controls, Tools, and Help) will be described.

### File

Before starting a test, the user must start a new session. In the **File** menu, click on **New** to define a new session.

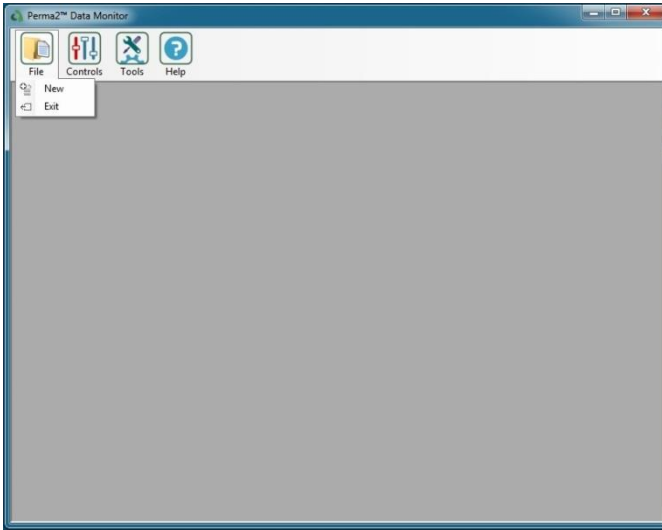

File Menu

A wizard will appear on the screen. The user has to fill in the necessary information to start a new test session.

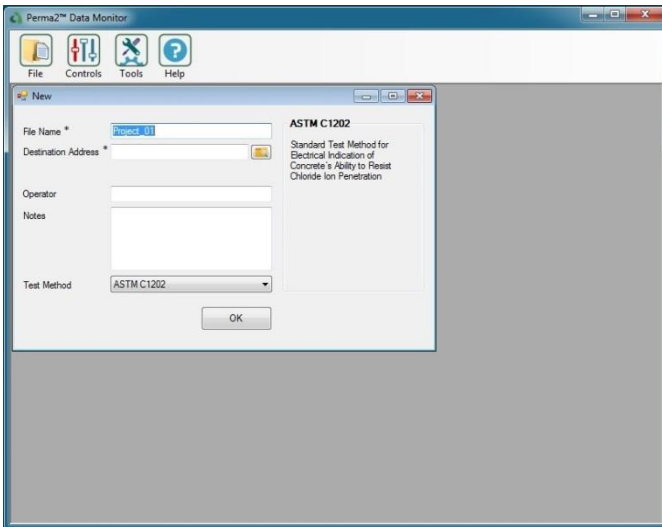

New Session Wizard

*Output files: Name and Destination*

In the wizard form, the user has to enter a valid file name, and select a destination address. The file name will be used to create the output file. The destination address is the location where the output file will be saved in. The user can also change the destination folder.

*Additional Information*

The user is encouraged to fill in the name of the operator for their records. Any additional notes can be added in the Notes box.

*Select Test Method*

The test method can be selected using the dropdown menu bar at the bottom of this form. The user can select from the two available standard test procedures, ASTM C 1202, and ASTM C 1760.

Press **OK** to continue.

Depending on the selected test method, the appropriate Data Monitor form will appear on the screen.

**ASTM C1202**



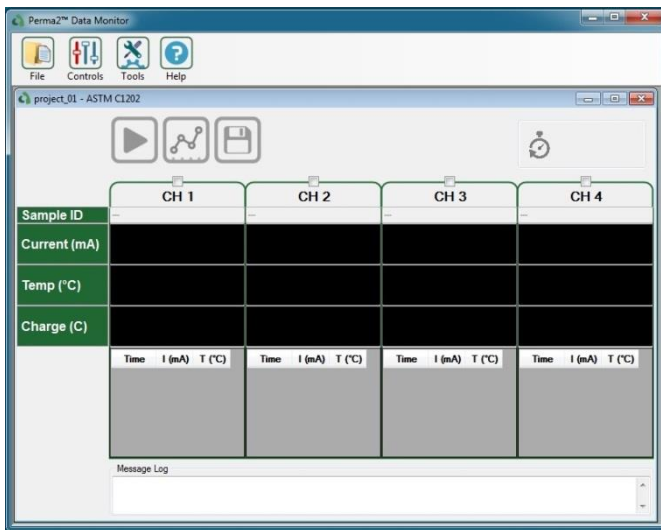





The Data Monitor form for the ASTM C1202 test methods helps the user control the device, and log the test data. It provides a user-friendly environment to view the real-time test data, as well as the visualization of the data (real-time plotting option).



ASTM C1202 Test Method

**Control Keys**

On the top of the form, the user can find the control keys. The control keys are set to be inactive (in light grey color) when no channel is selected for the test. As soon as the user selects the test channel(s), the Start key will be enabled. More information on the Control Keys is provided in the following table.

Icon Name	Default	Enabled	When
Start			After selecting test channel(s)
Chart			After the first set of data is logged
Save			When the test is successfully completed or after pressing Stop
Timer			Soon after pressing Start
Stop	-		After pressing Start

### Timer

According to the ASTM C1202, the total duration of the test is 6:00 hours. A timer will appear on the top-right side of the form, showing the remaining time of the test.

### Test Channels and Data Monitor

**a) Select Channel:** In order to perform the test, the user must select the channels that are connected to the device. Click on the check marks in order to select the test channels.

**b) Sample ID:** Once you have checked a test channel, the Sample ID box will be activated. Fill in the text box to identify the sample ID. This will help to document the test results better.

**c) Real-Time Data:** When the test starts, the current and temperature values will be measured by the device. The data will appear on the screen next to the Current and Temperature boxes. At each step and for each channel, the software will calculate the total Charge that has passed through the concrete sample.

**d) Data Log Table:** The real time data logging will be displayed in tabulated format right under the channel box.

**Message Log**

A message log box located at the bottom of the form will log any errors that might have occurred during the test. The user can scroll the box to view multiple messages.



ASTM C 1202 Test Running

Alternatively, the user can use the control keys under the Controls menu item to proceed with the test.

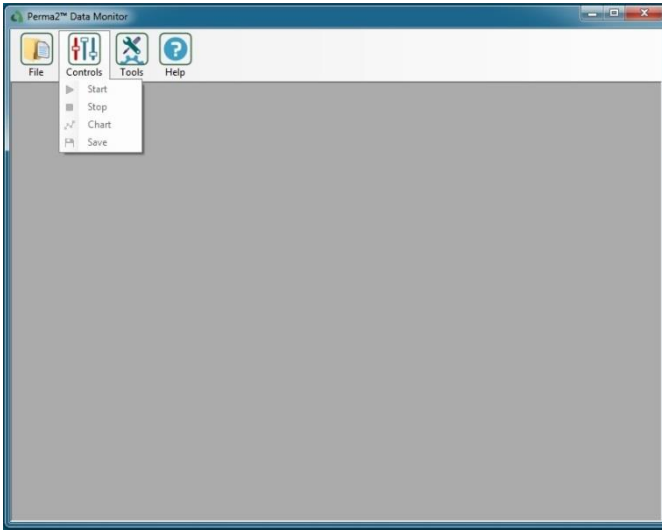

ASTM C1202 Test Method

**ASTM C1760**

The control keys and data monitor sections are customized to help the user with the ASTM C1760 test procedure. In this test method, the value of electrical current at the end of 1-minute test will be displayed for any selected channel(s).

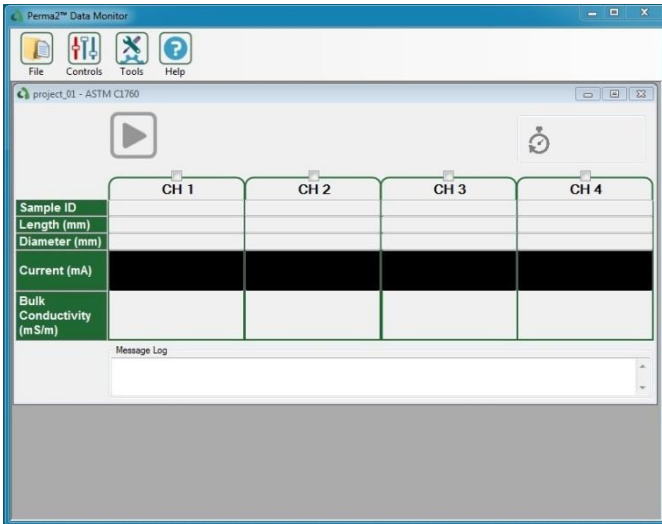





ASTM C1202 Test Method



## Control Keys

On the top of the form, the user can find the control keys. The control keys are set to be inactive when no channel is selected for the test. As soon as the user selects the test channel(s), the Start key will be enabled. More information on the Control Keys is provided in the following table.

Icon Name	Default	Enabled	When
Start			After selecting the test channel(s)
Timer			Soon after pressing the Start key
Stop	-		After pressing the Start key

## Timer

According to the ASTM C1760, the total duration of the test is set to 1:00 minute. A timer will appear on the top-right side of the form, showing the remaining time of the test.

## Test Channels and Data Monitor

**a) Select Channel:** In order to perform the test, the user has to select the channels that are connected to the device. Click on the check marks in order to select the test channels.

**b) Sample ID:** Once you have checked a test channel, the Sample ID box will be activated. Fill in the text box to identify the sample IDs. This will help to document the test results better.

**c) Length/Diameter:** Before starting the test, fill in the dimensions of the test sample (the length and diameter of the cylinder). These values will be used to determine the bulk conductivity of concrete samples.

### Message Log

A message log box located at the bottom of the form will log any errors that might have occurred during the test. The user can scroll the box to view multiple messages.

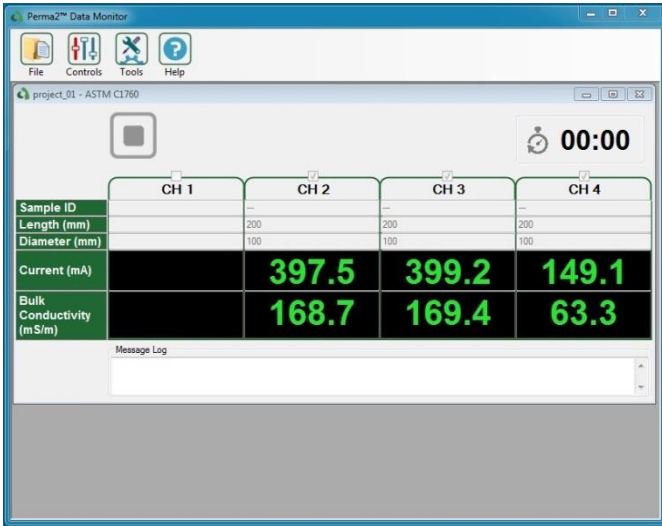

ASTM C1760 Test Method Running

## FIRMWARE UPGRADE

If there is any update for the firmware of the Perma2™ device, the firmware upgrade files will be sent to the customers. These files will be used to upgrade the firmware of the device. You can access the firmware upgrade from the Tools menu item.

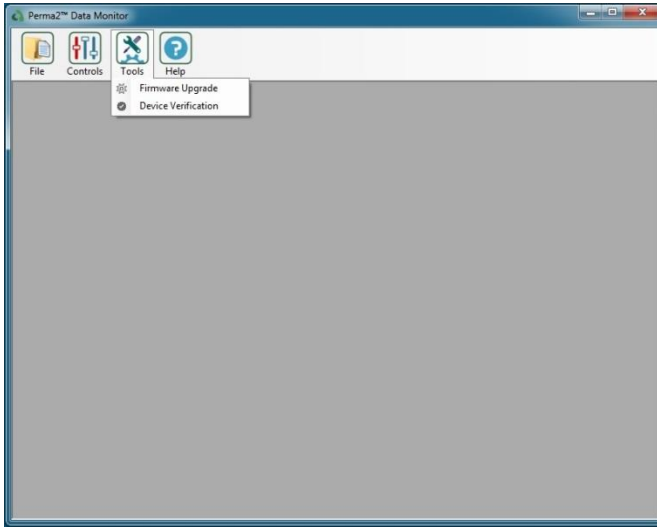

Firmware Upgrade

The user has to turn on the device in the Firmware upgrade mode. To do so, hold the Up key  and press the power switch on the back panel.

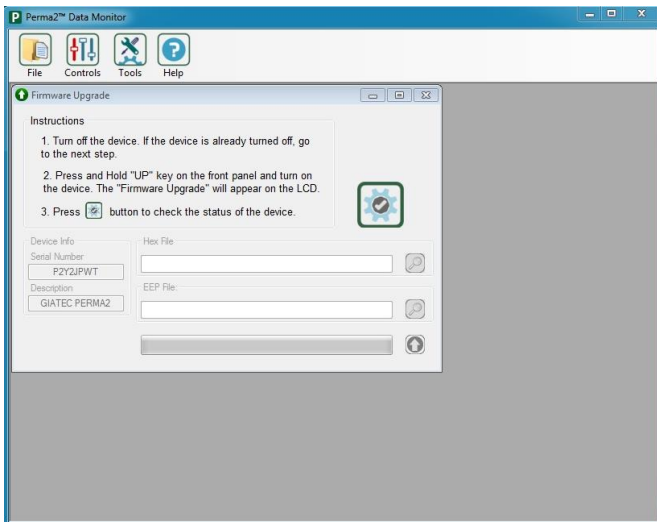

Firmware Upgrade

If the device is not in the correct mode, the user is asked to follow the instructions and try again. Click on the verify button to check the status of the device. If the device is appropriately set to **Firmware Upgrade** mode, the following screen will appear.

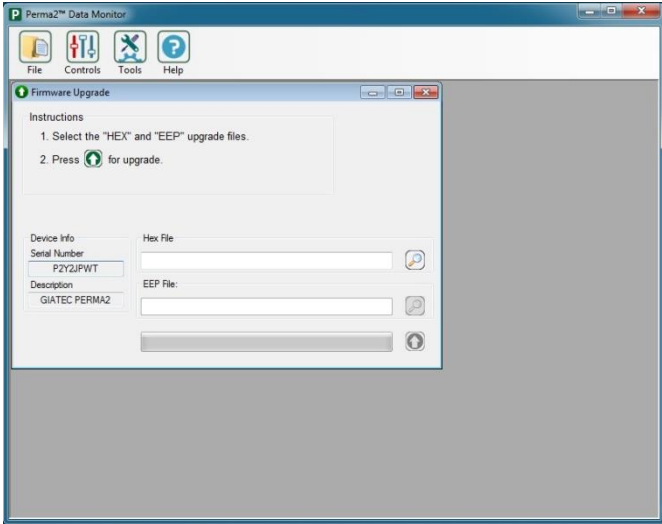

Select Upgrade files

Select the appropriate .Hex and .Eep files provided by Giatec Scientific Inc. Click on the Firmware upgrade button to start. Upon the successful completion, the following message will appear on the display and the device will return to the test mode:

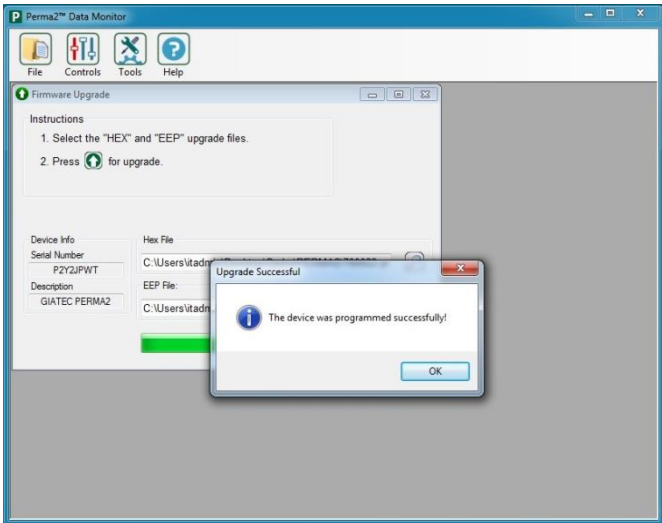

Firmware Upgrade Successful

## DEVICE VERIFICATION

A verification kit can be purchased with Perma2™ that can be used to ensure the appropriate functionality of the device. The verification kit contains various electrical circuits that generate known electrical charge when it is tested by the device.

To ensure appropriate functionality of the measurement system, verify the device with the verification kit from time to time. The verification procedure may be repeated, as required. If the device does not pass the verification procedure, the device should be returned to Giatec for hardware calibration. The hardware calibration is also advised to be conducted once per year to ensure the appropriate functionality and accuracy of the measurements. It is noted that the optional verification practice will not assure the required accuracy of the system and therefore, the calibration procedure is necessary to be conducted regardless of the verification practice.

The verification of the device can be performed from the main menu option on the front panel of the device. Alternatively, you can verify the device by using the Data Monitor software.

### Using the Front Panel

From the main menu, go to the **Device verification** option and press the Select key.

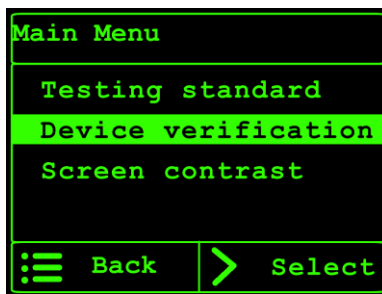

Select Device Verification

The user will be asked to connect the ports of the verification kit to the corresponding channels on the front panel of the device.

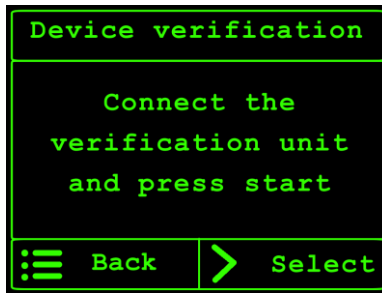

Select Device Verification

Press the start  key to initiate the verification process. Once the verification process is completed, the results will be displayed on the LCD screen:

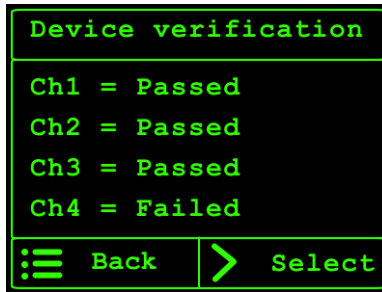

Device Verification Results

### Using Data Monitor Software

The user can also verify the accuracy of the device using the Data Monitor software by connecting the device to the verification kit. Connect channels 1 to 4, to the corresponding channels on the front panel of the device.

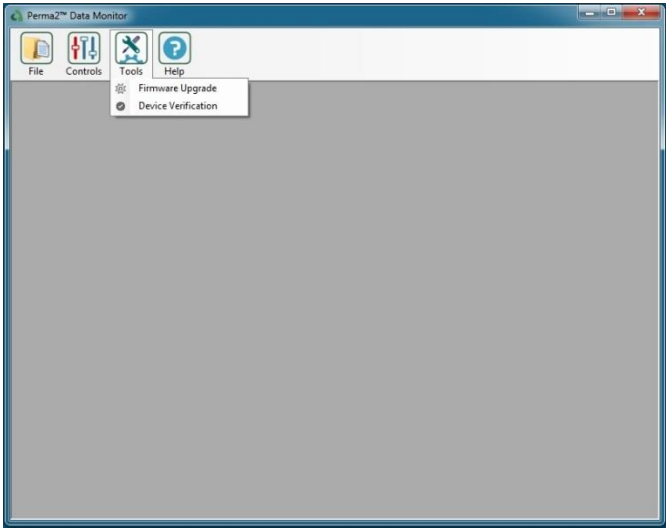

Device verification

If the channels Pass the verification test, a Pass message will appear in the text box. For channels failing the test, a Fail message will appear.

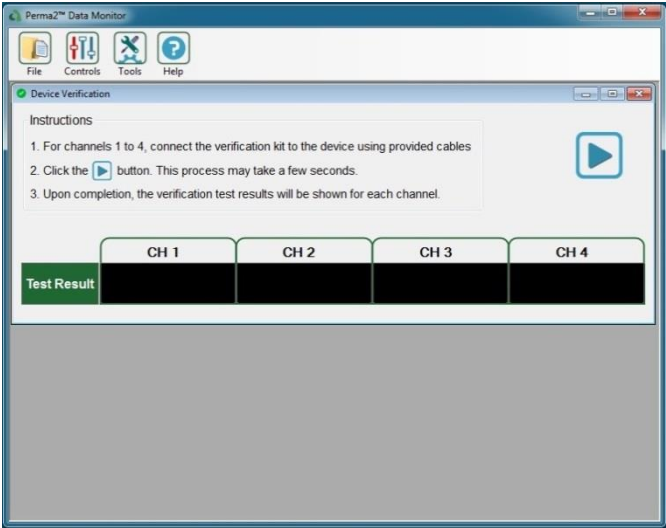

Device Verification

## MAINTENANCE

---

Repairs and servicing not covered in this manual should only be performed by qualified personnel. Periodically wipe the case with a damp cloth. Do not use abrasives or solvents.

### SERVICE

If Perma2™ does not start, check the power supply cord to see if it is connected properly. If Perma2™ still does not work properly, review this manual to make sure you are operating it correctly.

If Perma2™ malfunctions, first try to check its functionality using the verification kit. If that fails, call our technical support line number provided on the back of this manual. Only after consulting with our technical support department, pack the device securely in its original shipping container and forward it to the nearest service center. Please include a description of the malfunction.

### REPLACEMENTS

When servicing Perma2™, use only the replacement part specified. The USB communication cable is intended to be used only by Perma2™ device and connecting it to other instruments will damage the cable. To order replacement parts call Giatec Scientific Inc. using the number provided on the back of the manual or on the back of the device.



---

**Perma2™ TECHNICAL SPECIFICATIONS**

---

**GENERAL**

Type	Value
Applied Voltage*	60 ± 0.1 V
Range of Current Measurement*	0 ~ 500 ± 0.1 mA Or ±0.2% (whichever greater)
Temperature Measurement Range	0~100 ± 1°C
Measurement Channels	4
Short Circuit Protection System	Yes
Data Display on LCD	Yes
Timer Display on LCD	Yes
LCD Display Area	65 mm × 33 mm
Dimensions of Device	280 mm × 240 mm × 104 mm
Weight	2 Kg

\* *When the ASTM C1202 test is operated.*

**OPERATING CONDITIONS**

Type	Value
Operating temperature	15°C ~ 45°C
Operating humidity	30 ~ 80%
Storage temperature	0 ~ 70°C
Operating voltage/current	100 ~ 240 V, 50/60Hz

## TERMS AND CONDITIONS OF SALE ("SALE AGREEMENT")

---

Please read this Sale Agreement before using the Giatec Scientific Inc. ("Giatec") product (the "Product"). By finalizing Your purchase order, You, the purchaser of the Product, and, if applicable, any end user ("End User") on whose behalf You are making this purchase for (You and the End User are hereafter collectively referred to as "Customer"; Customer and Giatec are hereafter together referred to as "Parties") agree to be bound by and accept the terms and conditions provided below. If You and/or the End User, as the case may be, disagree with these terms and conditions, do not finalize Your order, or if the order has been placed, return the Product immediately upon receipt without using it.

**Payment; Purchase Price and Associated Charges.** Payment must be made at the time of order unless otherwise agreed to by the Parties. Customer will pay the total purchase price plus shipping and handling, if any, as specified on the emailed invoice. Customer is also responsible for all taxes related to this purchase and to the import of the Product, if applicable, to include but not limited to all sales taxes, value-added taxes, import taxes/customs/duties and any other similar taxes imposed by any governmental entity.

**Title; Risk of Loss.** Title to the Product passes to Customer when the Product is paid for in full. However, Giatec bears all responsibility for loss of or damage to the Product during initial shipment after purchase and until Product is received by Customer, unless Customer selects its own mode of shipping. In repair cases, risk of loss is borne by Customer for return of the Product, but by Giatec following repair and upon return to Customer.

**Limited Warranties.** Giatec warrants the Product against defects in materials and workmanship under normal use (the "Warranty") for a period of 12 months (#) from the Delivery Date (the "Warranty Period"), on the condition that the Product has been completely paid for. Unless as otherwise mandated by local law, the Warranty Period does not restart if Customer receives a replacement appliance and/or replacement Software. This Warranty does not apply: (a) to consumable parts, such as batteries, Plexiglas cell units and cables unless damage has occurred due to a defect in materials or workmanship; (b) to cosmetic damage, including but not limited to scratches, dents and broken plastic on ports; (c) to damage

caused by accident, abuse, misuse, neglect or failure to properly maintain (to include but not limited to water damage and/or condensation or improper temperatures during storage), or improper installation; (d) to damage caused by electrical disturbances or acts of God, to include but not limited to civil disturbance, war, flood, fire, rodents or insects; (e) where manufacturer's serial numbers and security labels have been removed from the Product; and (f) to damage caused during shipment (due to Customer's improper packaging) from Customer to Giatec in the case of Product returns for repair.

Giatec disclaims all other warranties, express or implied, including without limitation implied warranties of merchantability, fitness for a particular purpose, or against hidden or latent defects. Giatec's responsibility for warranty claims is limited to repair or replacement. Giatec reserves the right to modify this Warranty at any time, at its sole discretion, and with notice to Customer.

Giatec does not warrant that the operation of the Product will be uninterrupted or error-free. Giatec is not responsible for damage arising from failure to follow instructions relating to the Product's use. This Warranty is voided immediately if repair, modification (to include upgrades, expansions or usage or addition of non-manufacturer parts or accessories), alteration or other service is attempted other than by Giatec. In this regard, the integrity of the appliance casing (aka the box) should not be violated for any reason, unless expressly authorized by Giatec in writing.

**Technical Support.** Giatec will provide technical support to Customer in accordance with the then-current support policy in effect and in accordance with the Warranty provided herein, unless full payment for the purchase of the Product is not received. Giatec will respond to Customer support problems by phone or by email inquiry. If a support problem cannot be rectified via phone or email, Customer will be provided with return instructions.

Customer agrees and understands that it may be necessary for Giatec to collect, process and use Customer data to perform the support and repair obligations identified herein. This may include the necessity to transfer data to affiliate third parties that are contracted with Giatec to assist in meeting these obligations. In doing so, Giatec will (i) protect and keep confidential such information, (ii) not use such information for reasons

other those discussed above, and (iii) not sell, distribute or pass on such information to any third party.

**Repair.** Customer should carefully inspect the Product upon its delivery. Customer should maintain all original packaging upon receiving the Product until the Product has been installed and is found to be in proper working order.

If the Product arrives to Customer (the date of arrival is referred to herein as the “Delivery Date”) damaged or defective at initial delivery, Customer must notify Giatec Technical Support within 30 days from the Delivery Date of the condition of the Product and obtain return instructions if needed. Product must then be returned immediately to Giatec for repair or replacement at Giatec’s discretion. Giatec will then arrange for delivery of temporary or permanent replacement Product. Customer is responsible for properly packing the return shipment of the Product. Giatec will arrange for shipping and insurance.

If Customer fails to notify Giatec within 30 days of the Delivery Date, (i) the Refund Policy below will not apply, (ii) Customer will bear the cost of returning the Product for repair, and (iii) damaged Product will not be accepted.

If during the Warranty Period (as described herein) but following the initial 30 day period the Product is not working properly, Customer must contact Giatec Technical Support to confirm the problem and obtain return instructions if needed. Customer will pay shipping and insurance costs when returning the Product for repair.

If the Product is returned for repair or replacement at any time following purchase by Customer and Giatec discovers that the Warranty is inapplicable due to the reasons provided above (see the “Limited Warranties” section hereof), the Product will not be repaired and will be returned to Customer at Customer’s expense, unless Customer authorizes and pays for repair. Whether Customer authorizes repair or not, Giatec reserves the right to charge a “No Fault Found” fee where the Product is found not to be defective due to any fault of Giatec.

Any Giatec reseller or distributor involved in the purchase of the Product is not authorized to make any modification, extension, or addition to the Limited Warranties provided by Giatec herein, although any such reseller

or distributor may provide its own warranty in addition to the warranty coverage provided by Giatec.

**Refund Policy and Product Return.** On a case-by-case basis, Giatec reserves the right to authorize a full refund of any Product purchase made where a refund is requested within 30 days of the Delivery Date. In such cases where a refund is approved, End User will return the Product to Giatec if the End User made such order itself. If the Product was ordered by a distributor or reseller, such distributor or reseller will coordinate with Giatec for the return of the Product. In either case, Customer is responsible for shipping and insurance charges and any damage to the Product which takes place en route to Giatec. Giatec reserves the right to charge a nominal re-stock fee for any such returns.

**Limitation of Liability.** Giatec is not liable under any other agreement between End User and a Giatec reseller or distributor for the provision of support (to include but not limited to an extended warranty or any support, service or repair agreement).

If found to have breached this Sale Agreement, Giatec is not liable for any amount above the aggregate dollar amount paid by Customer for the purchase of the Product under this Sale Agreement. Except as provided in the Warranty and to the extent permitted by law, Giatec is not responsible for indirect, special, incidental or consequential damages resulting from any breach of this Sale Agreement, including but not limited to loss of use; loss of revenue; loss of actual or anticipated profits (including loss of profits on contracts); loss of the use of money; loss of anticipated savings; loss of business; loss of opportunity; loss of goodwill; loss of reputation; loss of, damage to or corruption of data or software programs; or any indirect or consequential loss or damage howsoever caused including the replacement of equipment and property, any costs of recovering, programming, or reproducing any program or data stored or used with the Product and any failure to maintain the confidentiality of data stored on the product. The foregoing limitation shall not apply to death or personal injury claims, or any statutory liability for intentional and gross negligent acts and/or omissions.

**Not For Resale.** The Product may not be purchased for resale purposes by Customer unless Customer is a legal and authorized reseller of Giatec products.

**High Risk Uses.** Customer will not purchase the Product for usage in connection with any high risk or strict liability activity (including, without limitation, air travel, space travel, firefighting, police operations, vehicle operations, power plant operations or power generation applications, transport management systems, military operations, rescue operations, hospital and medical operations or the like) whereby such usage could cause or contribute to damage to property or injury to persons.

**Software License.** The Product is and contains, the intellectual property of Giatec, and is protected by Canadian, U.S. and international copyright, patent, trade secret laws and international treaties. This Agreement is not intended to grant, and shall in no way be construed to grant, to Customer any rights in the intellectual property of Giatec, including the intellectual property in the Products. The Customer shall obtain a non-exclusive license to use the software contained in the Product (the “Software”) only in accordance with the terms of the Software License Agreement, attached hereto as Exhibit A, and the Customer shall agree with its terms prior to installing the Software. Customer acknowledges that the Software is the intellectual property of Giatec and respects Giatec’s rights as the intellectual property rights holder. Customer may not and customer agrees not to, or to enable others to, copy, decompile, reverse engineer, disassemble, attempt to derive the source code of, decrypt, modify, or create derivative works of the Software or any part thereof (except as and only to the extent any foregoing restriction is prohibited by applicable law). Any attempt to do so is a violation of the rights of Giatec. By virtue of this Sale Agreement, Customer acquires only the right to use the Software as contained in the Product and does not acquire any rights of ownership. All rights, title and interest in the Software shall at times remain the property of Giatec.

**Product Disposal/Recycling.** Giatec is unable to dispose of or recycle the Product following use. End User may dispose of recycle the Product or arrange for the same through the Giatec distributor or reseller which made the Product sale. Any disposal or recycling of the Product must be done in accordance with local government directives.

**Export.** Customer must comply with all export laws and restrictions and regulations of Canada. Furthermore, Customer will not export, or allow the export or re-export of the Product in violation of any such restrictions, laws or regulations. Additionally, Customer agrees to comply with the above and represents and warrants that it is not located in, under the control of, or a resident of any restricted country.

**Entire Agreement.** This Sale Agreement constitutes the entire understanding of the Parties as to the subject matter hereof and supersedes all prior offers, agreements, arrangements, negotiations and understanding, written or oral between the parties relating to that subject matter.

**Severability; Assignment.** If any provision of this Sale Agreement is held to be unenforceable for any reason, the legality or enforceability of the remaining terms shall not be affected or impaired. The failure of Giatec to act with respect to a breach of this Sale Agreement by Customer or others does not constitute a waiver and shall not limit Giatec's rights with respect to such breach or any subsequent breaches. Giatec expressly reserves the right to assign this Sale Agreement and to delegate any of its obligations hereunder. Customer may not assign, delegate or otherwise transfer (whether by operation of law or otherwise) this Sale Agreement or any of Customer rights or obligations hereunder without the prior written consent of Giatec. Giatec may assign the provision of repair services to third parties.

**Governing Law; Dispute Resolution.** All disputes arising out of or in connection with this Sale Agreement shall be finally settled under the Rules of Arbitration of the International Chamber of Commerce by one or more arbitrators appointed in accordance with the said Rules. The place of arbitration shall be Ottawa, Ontario, Canada. The language of the arbitration shall be English. For the purposes of this arbitration, this Sale Agreement shall be governed by and construed under Ontario law as such law applies to agreements between Ontario residents entered into and to be performed within Ontario, Canada. The decision of the arbitrators shall be binding upon the parties hereto, and the expense of the arbitration (including without limitation the award of attorneys' fees to the prevailing party) shall be paid as the arbitrators determine. The decision of the arbitrators shall be executory, and judgment thereon may be entered by any court of competent jurisdiction.

Any non-English language translation of this Sale Agreement is done for local requirements and in the event of a dispute between the English and any non-English versions, the English version of this Sale Agreement shall govern.

## EXHIBIT A: END USER SOFTWARE LICENSE

### **IMPORTANT**

**PLEASE READ THE TERMS AND CONDITIONS OF THIS SOFTWARE LICENSE AGREEMENT CAREFULLY BEFORE AGREEING TO INSTALL THE SOFTWARE. THIS IS A LEGAL AGREEMENT BETWEEN GIATEC AND THE END USER ("CUSTOMER").**

**GIATEC IS WILLING TO LICENSE THE SOFTWARE WITH WHICH THIS AGREEMENT IS PROVIDED ("THE SOFTWARE") TO THE CUSTOMER UTILIZING THE SOFTWARE ONLY ON THE CONDITION THAT THE CUSTOMER, ACTING THROUGH YOU, THE CUSTOMER'S AUTHORIZED AGENT, ACCEPT ALL OF THE TERMS OF THIS AGREEMENT.**

**BY CLICKING ON THE "I ACCEPT THE TERMS IN THE LICENSE AGREEMENT" RADIO BUTTON BELOW, YOU, ON BEHALF OF CUSTOMER, AGREE TO, AND ARE LEGALLY BOUND BY, THE TERMS AND CONDITIONS OF THIS AGREEMENT.**

**IF YOU DO NOT AGREE WITH, AND DO NOT WISH TO BE LEGALLY BOUND BY, THE TERMS AND CONDITIONS OF THIS AGREEMENT DO NOT CLICK ON THE "I ACCEPT THE TERMS IN THE LICENSE AGREEMENT" RADIO BUTTON AND THE INSTALLATION PROCESS WILL STOP.**

### **Copyright/Proprietary Protection**

The Giatec Software (the "Software") and the Documentation (all of the online help files and manuals, and all of the printed material included with this Software) are owned by Giatec and are protected by Canadian, United States and international copyright laws and international treaty provisions. You must treat this Software like any other copyrighted material, with the exceptions outlined in the following License Grant. Any violation of this agreement will automatically terminate your right to use this Software, and you must immediately return it to Giatec.

Giatec trademarks contained in the Software are trademarks or registered trademarks of Giatec in Canada, the United States and/or other countries. Third party trademarks, trade names, product names and logos may be the trademarks or registered trademarks of their respective owners. You may not remove or alter any trademark, trade names, product names, logo or other proprietary notices, legends, symbols or labels in the Software.

### **License Grant**

Giatec grants you a nonexclusive license to use this Software on a single (dedicated) computer. You may copy this Software onto the hard disk of this computer, and make one copy for archival purposes. You may not make copies of the Software for any purpose other than what is stated above. You may not copy the Documentation for any reason. You may not reverse engineer, disassemble, decompile or attempt to discover the source code of the Software. You may not modify the Software or create derivative products using this Software. You may not sublicense, rent or lease any portion of the Software. You may transfer your rights under this agreement on a Perma2nent basis to another person or entity provided that you transfer this License Agreement, all original and updated Software and Documentation, and that you not retain any copies of the Software or Documentation. You must notify Giatec in writing of your transfer, and the recipient must also agree to the terms of this License Agreement. If you want to share the Software on a network, please contact Giatec to request a Network License Agreement.



## **Limited Warranty**

Giatec warrants the physical compact disk(s) on which the Software is distributed to be free from defects in materials and workmanship and that the Software will function in substantial accordance to the specifications for a period of one (1) year from the date of shipment of the Software to Customer. General and specific limitations on this warranty are described in Giatec's "Warranty" statement, and are incorporated by reference. THE WARRANTIES DESCRIBED HEREIN AND/OR ACCOMPANYING PRODUCTS ARE IN LIEU OF ALL OTHER WARRANTIES OR CONDITIONS AND, SAVE AS OTHERWISE PROVIDED HEREIN, GIATEC MAKES AND THERE ARE NO OTHER WARRANTIES OR CONDITIONS OR REPRESENTATIONS OF ANY KIND WHETHER EXPRESSED OR IMPLIED, AND GIATEC EXPRESSLY DISCLAIMS THE IMPLIED WARRANTIES OR CONDITIONS OF MERCHANTABILITY, FITNESS FOR A PARTICULAR PURPOSE, AND THOSE ARISING BY STATUTE OR OTHERWISE IN LAW OR FROM A COURSE OF DEALING OR USAGE OF TRADE. GIATEC DOES NOT REPRESENT OR WARRANT THAT THE PRODUCTS WILL MEET ANY OR ALL OF ANY ORGANIZATION'S PARTICULAR REQUIREMENTS, THAT THE OPERATION OF THE PRODUCTS WILL BE ERROR FREE OR UNINTERRUPTED. Any written or oral information or advice given by Giatec distributors, agents or employees will in no way increase the scope of this warranty.

## **No Liability for Consequential or Incidental Damages and Limitation of Liability**

IN NO EVENT SHALL GIATEC, ITS SUPPLIERS OR DISTRIBUTORS BE LIABLE FOR ANY CONSEQUENTIAL OR INCIDENTAL DAMAGES WHATSOEVER (INCLUDING, WITHOUT LIMITATION, DAMAGES FOR LOSS OF PROFITS, BUSINESS INTERRUPTION, LOSS OF INFORMATION, OTHER PECUNIARY LOSS OR ATTORNEY FEES) ARISING OUT OF THE USE OF OR THE INABILITY TO USE THIS SOFTWARE, EVEN IF GIATEC OR ITS SUPPLIERS OR DISTRIBUTORS HAVE BEEN ADVISED OF THE POSSIBILITY OF SUCH DAMAGES. BECAUSE SOME JURISDICTIONS DO NOT ALLOW THE EXCLUSION OR LIMITATION OF LIABILITY FOR CONSEQUENTIAL OR INCIDENTAL DAMAGES, THE ABOVE LIMITATION MAY NOT APPLY TO YOU. FURTHER, TO THE EXTENT PERMITTED BY LAW, IN NO EVENT SHALL GIATEC'S LIABILITY AS TO ANY AND ALL DAMAGES ARISING OUT OF THIS AGREEMENT OR THE USE OF SOFTWARE EXCEED THE AMOUNT PAID BY YOU FOR THE RIGHT TO USE THIS SOFTWARE.

## **Export Controls**

This Software is subject to the export control laws of Canada, the United States and applicable export and import control laws of other countries. You agree to comply with and use the Software in a manner consistent with such applicable laws. All rights to use the Software are granted on condition that such rights are forfeited if you fail to comply with this Agreement.

## **General Provisions**

This Agreement constitutes the entire agreement between you and Giatec and supersedes any prior agreement concerning the Software. Giatec is not bound by any provision of any purchase order or any other type of correspondence (written or verbal). Should any court of competent jurisdiction find any provision in this Agreement to be illegal, unenforceable, invalid, or to be overreaching, in whole or in part and for any reason, such illegal, unenforceable, invalid or overreaching provisions or part thereof shall be stricken from this Agreement, and such provision shall not affect the legality, enforceability, or validity of the remainder of this Agreement. This Agreement is governed by the laws of the Province of Ontario and any disputes or claims arising hereunder shall be under the exclusive jurisdiction of the courts situated in the City of Ottawa, Province of Ontario.













**GIATEC SCIENTIFIC INC.**  
301 MOODIE DRIVE, SUITE 302,  
OTTAWA, ON, K2H 9C4, CANADA

PHONE: +1 (613) 240-7451  
FAX: +1 (613) 280-1544  
SUPPORT@GIATECSCIENTIFIC.COM  
WWW.GIATEC.CA